







36 201 705

- inverseur rotatif
- rosace 60 x 60 mm



	Chrome	36 201 705-00
	Platine brossé	36 201 705-06
	Dark Chrome	36 201 705-19
	Champagne brossé (Or 22cts)	36 201 705-46
	Champagne (Or 22cts)	36 201 705-47
	Dark Platinum brossé	36 201 705-99

**Accessoires requis**



- Inverseur à 2 voies à encastrer - 35 202 970 90**
- profondeur de montage max. 160 mm
  - profondeur de montage mini. 115 mm

36 201 705

mm [inches]

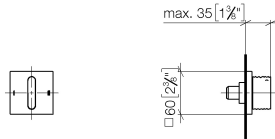

### Diagramme de débit



### Certificats

LGA\_38379.

WRAS\_2307045.

36 201 705

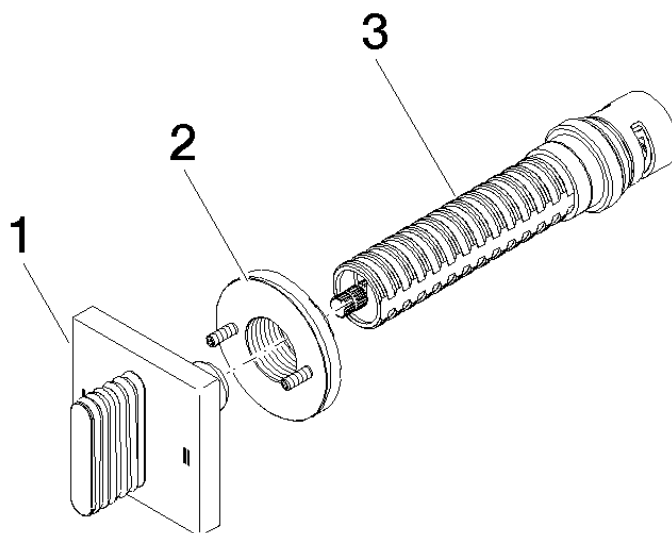

### Liste des pièces de rechange

N°	Article Numéro	Désignation	Fréquence de montage	Délai de livraison
1	90 20 70 055 08-00	poignée	1	10
2	90 21 02 181 00 90	rondelle	1	2
3	90 90 03 304 10 90	inverseur	1	2